



STAS DOYER

LES PIÈCES
DETACHÉES

2024

Table des matières

Les produits d'entretien.....	3
Les produits de soin WATERMASS.....	3
Carte électronique et claviers de commande	4
Détecteurs de niveau.....	5
Thermomètres & manomètre	6
Résistances / Sonde T°	7
Soufflantes / Pompes	8
Motoréducteurs & distributeurs	9
Pilotes	10
Electrovannes.....	11
Vannes No / NF	12
Robinets en bronze.....	13
Robinets en PVC.....	14
Mitigeurs thermostatiques.....	15
Pommes et jets.....	16
Queues de carpe.....	20
Cale pieds.....	20
Douchettes	20
Becs de remplissage.....	21
Arroseurs Oscillants.....	22
Pièces Pompe WATERMASS.....	23
Tête WATERMASS.....	24
Pièces WATERMASS	25
Pièces HYDROMEL.....	26
Bavettes et passages Mains/pieds	27
Tuyaux et flexibles.....	29

Les produits d'entretien

SAVON NOIR (5 litres)	000 024 371
HOROLITH FL (20 litres)	000 024 371

SAVON NOIR → NETTOYANT DEGRAISSANT TOUTES SURFACES

Conditionnement 5 L

Nettoyant dégraissant toutes surfaces et adapté au WATERMASS

Dilution 1 bouchon par litre d'eau chaude

Application : Trempage de la tête WATERMASS / Aspiration

HOROLITH FL → DETARTRAGE

Conditionnement 20 L

Détartrant acide phospho-nitrique

Détartrage de surface, trempage ou circulation

Dilution entre 2 et 10 % en fonction de degré d'entartrage

Application : 30 minutes à une température comprise entre 20 et 60 °C.

Danger : Acide soumis à réglementation. A appliquer avec les protections adaptées.

Les produits de soin WATERMASS



LIBELLES	REFERENCES
Huile de soin WATERMASS (500 ml)	090 010 901
Gel fermeté WATERMASS (150 ml)	090 010 902

HUILE DE SOIN

L'huile WATERMASS est adaptée à l'utilisation sous affusion d'eau.



Elle vous permettra de réaliser le soin avec facilité, son pouvoir glissant vous permettra de réaliser toutes les manœuvres du soin sans décrocher la tête WATERMASS de la peau.

GEL FERMETE

Le gel fermeté est à appliquer en fin de soin mais également à proposer à la vente pour intensifier les résultats des séances WATERMASS, hydrater et assouplir la peau.

Un gel qui pénètre rapidement et ne laisse pas de résidus collants. Pratique pour une utilisation matin et soir après la douche.

Carte électronique et claviers de commande

	LIBELLES	REFERENCES
	Clavier 8 touches Montage sur Coque	200 130 010
	Clavier 8 Touches sur pieds	200 130 030
	<u>Ecrans tactiles :</u> 5,7"	219 804 030
	4,3"	219 804 026
	<u>Pupitres tactiles :</u> 5,7"	200 230 015
	4,3"	200 230 016
	Carte électronique	219 400 107

Détecteurs de niveau

	LIBELLES	REFERENCES
	<p style="text-align: center;"><u>Pressostats 1 seuil :</u></p> <p style="text-align: center;">50/25</p> <p style="text-align: center;">60/30</p> <p style="text-align: center;">165/75</p> <p style="text-align: center;"><u>Pressostats 2 seuils :</u> <i>(Obsolète → Nous contacter pour solution remplacement)</i></p>	<p style="text-align: center;">203 401 004</p> <p style="text-align: center;">203 401 003</p> <p style="text-align: center;">203 401 002</p>
	<p>Flotteur aimanté</p>	<p>028 121 011</p>
	<p>Kit tube détecteur de niveau</p>	<p>028 004 000</p>
	<p>Détecteur BRK</p>	<p>028 121 033</p>
	<p>Capteur niveau (2024) PP NO</p>	<p>218 220 005</p>

Thermomètres & manomètre

		LIBELLES	REFERENCES
		Thermomètre 0-60°C	000 024 160
		Thermomètre 0-100°C	000 024 148
		Manomètre 0-10 bars	000 024 140
		Manomètre 0-25 bars Ø63 INOX RA 14 GLY	000 024 141

Résistances / Sonde T°

		LIBELLES	REFERENCES
		LYDO / HYDROMEL Résistance électrique 1000W	050 000 055
		CHROMOTHERM Résistance électrique 3000W 230V	050 000 051
		DIME Résistance électrique 4500W	050 000 056
		<u>Sonde T° Baignoires :</u> 2.5 m 7 m	205 101 123 205 101 124
		HYDROMEL / THALAXION Sonde T°	218 220 003



Soufflantes / Pompes

	LIBELLES	REFERENCES
	<p style="text-align: center;">SOUFFLANTE HPE 0.37KW MONO 115-230V 50&60 HZ <i>(Standard Baignoires)</i></p>	<p style="text-align: center;">000 031 002</p>
	<p style="text-align: center;">SOUFFLANTE HPE 0.37KW TRI 200-230-400V 50&60 HZ</p>	<p style="text-align: center;">000 031 003</p>
	<p style="text-align: center;">SOUFFLANTE HPE 0.2KW <i>(BALI, PHLEBOTONE)</i></p>	<p style="text-align: center;">000 031 035</p>
	<p style="text-align: center;"><u>Pompe LOWARA :</u> Triphasée eau de mer 32-160/22 40-160/40 40-200/55 Eaux douces 32-160/22 40-160/40 40-200/55</p>	<p style="text-align: center;">000 030 290 000 030 249 000 030 229 000 030 237 000 030 251 000 030 227</p>
	<p style="text-align: center;"><u>Garniture pompe</u> <u>LOWARA ESHE 2,2/4/5,5 :</u></p> <p style="text-align: center;">Garniture eau douce</p> <p style="text-align: center;">Garnitures eau de mer</p>	<p style="text-align: center;">000 025 411 000 025 406</p>
	<p style="text-align: center;"><u>Pompe LOWARA</u> <u>10HME03N15T05VBE :</u> <i>(BALI)</i> TRI</p> <p style="text-align: center;">MONO</p>	<p style="text-align: center;">000 030 268 000 030 256</p>

Motoréducteurs & distributeurs

	LIBELLES	REFERENCES
	Motoréducteur NECKAR	000 004 220
	Motoréducteur ORIENTAL MOTOR	000 004 218
	<u>Accouplements :</u> NECKAR ORIENTAL MOTOR	000 021 040 000 021 041
	Distributeur Bronze 4 voies <i>(HY 4 Zones + Série 120-121)</i>	000 012 062
	Distributeur Bronze 6 voies <i>(HY 6 Zones + Série 130-131)</i>	000 012 063
	Kit joints distributeurs	100 003 000
	<u>Moto-distributeur complet :</u> 4 voies <i>(HY 4 Zones + Série 120-121)</i> 6 voies <i>(HY 6 Zones + Série 130-131)</i>	000 004 230 000 004 231

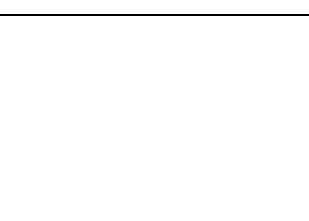

Pilotes

	LIBELLES	REFERENCES
	Pilotes individuel SMC	000 006 065
	Batterie 3 pilotes SMC <i>(Série 230-231)</i>	200 025 091
	Batterie 4 pilotes SMC <i>(Série 240-241)</i>	200 012 492
	Batterie 6 pilotes SMC <i>(Série 260-261)</i>	200 012 491



Electrovannes

		LIBELLES	REFERENCES
		Electrovanne Burkert 1/2" Type 6213 24V/50Hz	000 006 042
		Electrovanne Burkert 1" Type 213 24V/50Hz <i>(HYDROMEL)</i>	000 006 039
		Electrovanne AK MULLER 3/4" 24V/50Hz <i>(Rinçage)</i> Clapet AR	000 006 051 000 006 053
		Electrovanne AK MULLER 1"1/2 24V/50Hz <i>(Vidange PHLEBOTONE)</i>	000 006 050
		Bobine SMC seule	000 006 074
		Bobine AK MULLER seule	000 006 036





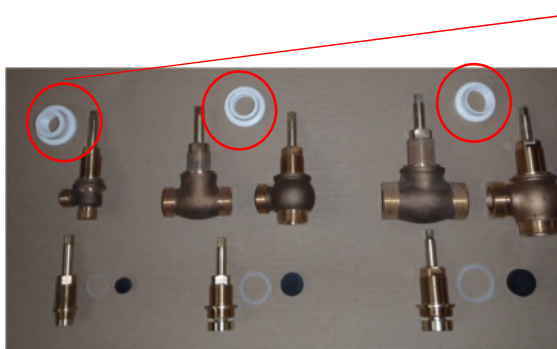

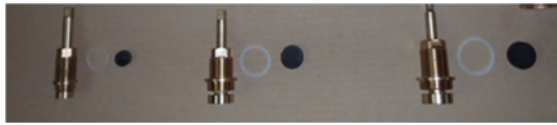
Vannes No / NF

	LIBELLES	REFERENCES
	<p><u>Vannes GEMU R690 NO :</u></p> <p style="text-align: center;"> DN15 DN20 DN25 (MOREA/JAMAIQUE) DN32 (Niagara) DN50 </p>	<p>028 121 037</p> <p>028 121 038</p> <p>028 121 029</p> <p>028 121 045</p> <p>028 121 027</p>
	<p style="text-align: center;"> Vanne GEMU Type 423 DN25 PP 24V/50Hz <i>(Remplissage baignoire)</i> </p>	<p>028 121 197</p>
	<p style="text-align: center;"> Vanne GEMU Type 423 DN50 PVC 24v/50Hz <i>(Vidange baignoire)</i> </p>	<p>028 121 134</p>

Robinets en bronze

	LIBELLES	REFERENCES
	Volant blanc complet	000 023 999
	<u>Caches tête :</u> Rouge Bleu Blanc	000 024 009 000 024 008 000 024 006
  	<u>Écrou de tête :</u> de 10 de 20 de 25 <u>Robinets complets :</u> L de 10 L de 20 L de 25 (<i>Baignoire+DJ</i>) Droit de 20 (<i>Affusions</i>) Droit de 25 <u>Têtes de robinet :</u> Tête de 10 Joint de tête de 10 Clapet Neopan de tête de 10 Tête de 20 Joint de tête de 20 Clapet Neopan de tête de 20 Tête de 25 Joint de tête de 25 Clapet Neopan de tête de 25	000 012 007 000 012 009 000 012 011 028 121 081 028 121 080 028 121 082 028 121 084 028 121 147 000 021 018 000 019 085 000 019 078 000 021 020 000 019 087 000 019 079 000 021 021 000 019 088 000 019 080

Robinets en PVC

	LIBELLES	REFERENCES
	Volant blanc complet	000 023 999
	<u>Caches tête :</u> Rouge Bleu Blanc	000 024 009 000 024 008 000 024 006
	Ecrou de tête de 10	000 012 007
	<u>Vanne GEMU PP</u> <u>Type 477 :</u> DN20 DN25	 028 121 203 028 121 210
	<u>Vanne GEMU PP</u> <u>Type 477 :</u> DN20 DN25	 028 121 211 028 121 199
	<u>Vanne papillon PP</u> <u>type 417 :</u> DN 20 court DN 20 long DN 25 long	 040 000 048 040 000 050 040 000 049

Mitigeurs thermostatiques

	LIBELLES	REFERENCES
 	<p><u>Mitigeur thermostatique :</u></p> <p>120L/min <i>(D'IME, Affusion, DJ)</i></p> <p>Cartouche</p>	<p>100 000 171</p> <p>000 025 225</p>
 	<p>Mitigeur 1/2" <i>(WATERMASS, TABLE D'IME)</i></p> <p>Cartouche 1/2"</p>	<p>100 000 171</p> <p>000 025 231</p>
	<p>Manette rosace chromée</p>	<p>041 200 760</p>

Pommes et jets

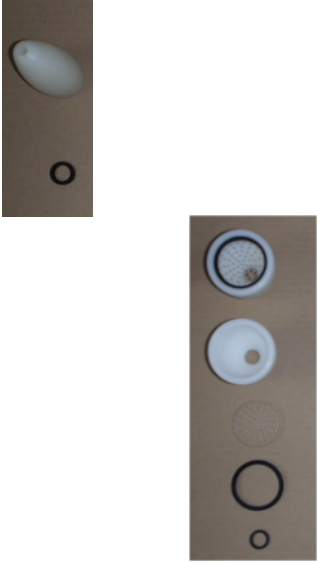
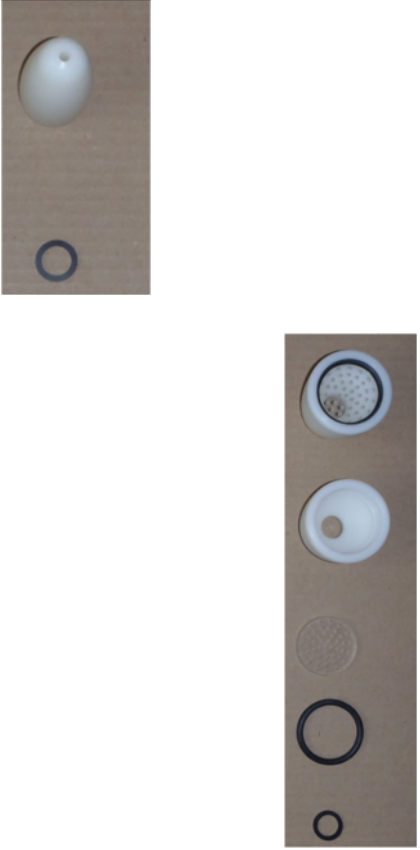

		LIBELLES	REFERENCES
Affusion 932/952			
	Pomme Ø50/84 Complète	000 012 000	
	Corps Ø50/84	000 012 001	
	Grille pomme Ø50	041 211 005	
	JT R27	000 019 029	
	JT R11	000 019 013	
Affusion D'IME / 953			
	Pomme Ø40/50 Complète	000 010 051	
	Corps Ø40/50	000 010 047	
	Grille pomme Ø40/50	000 010 046	
	JT R21	000 019 023	
	JT R8	000 019 010	

		<p style="text-align: center;">Axe arrêt 953</p>	<p style="text-align: center;">083 001 037</p>
Affusion 932 (Ancien modèle)			
		<p style="text-align: center;">Pomme Ø50 Complète</p> <p style="text-align: center;">Corps Ø50</p> <p style="text-align: center;">Grille pomme Ø50</p> <p style="text-align: center;">JT R27</p> <p style="text-align: center;">JT R11</p>	<p style="text-align: center;">000 021 048</p> <p style="text-align: center;">041 210 008</p> <p style="text-align: center;">041 211 005</p> <p style="text-align: center;">000 019 029</p> <p style="text-align: center;">000 019 013</p>
Lance affusion			
		<p style="text-align: center;">Jet Ø1/2" – 6 DN20</p> <p style="text-align: center;">Joint Plat 1/2"</p>	<p style="text-align: center;">000 010 009</p> <p style="text-align: center;">000 019 062</p>

Douche au Jet DJ92		
	Jet plat Ø3/4" – 8 DN25	000 021 045
	Joint Plat 3/4"	000 019 063
	Pomme Ø75 Complète	000 021 046
	Corps Ø75	011 410 004
	Grille pomme Ø75	011 411 004
	JT R33	000 019 035
	Joint Plat 3/4"	000 019 063
	Douche au Jet DJ914 / Francine	
	Jet Ø3/4 – 8 DN20	000 021 043
	Joint Plat 3/4"	000 019 063
	Pomme Ø60 Complète	000 021 047
	Corps Ø60	000 010 054
	Grille pour pomme Ø60	041 211 001
	JT R30	000 019 032
	Joint Plat 3/4"	000 019 063

Douche à colonne / Chromotherm		
	Pomme Ø40 Complète	000 021 049
	Corps Ø40	000 010 059
	Grille pour pomme Ø40	000 010 053
	JT R21	000 019 023
	Joint Plat 3/8"	000 019 061
Douche océane		
	Douche complète	041 210 015
	Pomme 1/2" Ø50/84	000 012 001
	Grille Ø40	041 211 005
	Joint torique R27	000 019 029
	Joint torique R11	000 019 013
	Axe arrêt 1/2"	083 000 519
	Robinet complet	001 200 023

Queues de carpe

	LIBELLES	REFERENCES
	Queue de carpe PVC Largeur 40mm Ø ¾"	000 010 074
	Queue de carpe PVC Largeur 40mm Ø ½"	000 010 073

Cale pieds

	LIBELLES	REFERENCES
	<u>Cale pieds complet :</u> Niagara 2 & 3 MOOREA Jamaïque XL Caraïbe ECO Provence Jamaïque 1 & 3 Niagara 1 Peninsule Caraïbe Baignoire 930	 027 000 401 032 021 010 028 021 000 024 021 000

Douchettes

	LIBELLES	REFERENCES
	Douchette à gâchette	000 024 548

Becs de remplissage

		LIBELLES	REFERENCES
		Bec de remplissage BORA BORA	083 001 057
		Bec de remplissage MOOREA-DULCE- NIAGARA 3	083 011 183
		Bec de remplissage thermal tournant pivotant 90° PEHD-INOX	024 122 040
		Bec Fixe JAMAIQUE 2 Standard	035 002 001

Arroseurs Oscillants

		LIBELLES	REFERENCES
		Arroseur Oscillant POLO + Rampe d'arrosage PVCC <i>(Affusion 952)</i>	041 200 023
		Arroseur Oscillant POLO turbine seule <i>(Affusion 952)</i>	000 024 247
		ZOOM MAX <i>(Affusion 953)</i>	000 024 519
		Embout d'alimentation Oscillateur <i>(Affusion 952)</i>	000 024 246
		Rampe d'arrosage PVC-C pour oscillateur <i>(Affusion 952)</i>	041 200 009
		Robinet Oscillateur <i>(Affusion 953)</i>	000 061 340

Pièces Pompe WATERMASS

	LIBELLES	REFERENCES
	<p style="text-align: center;">Kit diaphragme pompe WATERMASS 4 têtes Type R4300-540A</p>	<p style="text-align: center;">090 010 045</p>
	<p style="text-align: center;">Kit valves pompe WATERMASS 4 têtes Type R4300-540A</p>	<p style="text-align: center;">090 010 041</p>
	<p style="text-align: center;">Kit diaphragme VITON WATERMASS 2 Têtes Type D3732-V50</p>	<p style="text-align: center;">090 010 052</p>
	<p style="text-align: center;">Kit valves VITON WATERMASS 2 Têtes Type D3732-V50</p>	<p style="text-align: center;">090 010 051</p>
	<p style="text-align: center;">Pompe WATERMASS 4 Têtes</p>	<p style="text-align: center;">090 010 049</p>

Tête WATERMASS

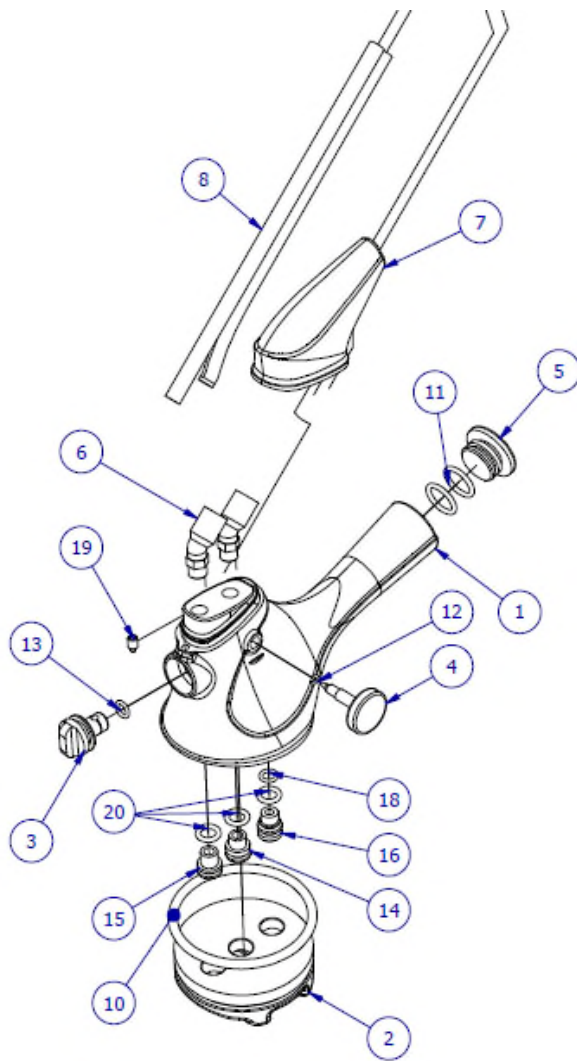

LISTE DE PIECES			
ARTICLE	QTE	NUMERO DE REV	TITRE
1	1	083000943	CORPS
2	1	083000944	TETE BASSE
3	1	083000949	ROBINET D'EAU
4	1	083000950	VIS DEPRESSION
5	1	083000952	BOUCHON MOLETÉ
6	2	090010026	RACCORD COUDÉ 45° Ø8 - 1/8" M
7	1	083000945	CACHE PU
8	1	090010011	FLEXIBLE BI TUBE Ø5x8
10	1	000019145	JOINT TORIQUE R37
11	2	000019015	JOINT TORIQUE R13
12	1	000019150	JOINT TORIQUE Ø4.00x1.50
13	1	000019008	JOINT TORIQUE R5a
14	1	083000948	RACCORD AIR
15	1	083000947	RACCORD EAU
16	1	083000948	RACCORD HUILE
18	1	000019033	JOINT TORIQUE R6
19	1	083000951	VIS A TETON
20	3	000019010	JT Ø8.90x2.70 R8

Pièces WATERMASS



	LIBELLES	REFERENCES
	BI-TUBE 4 mètres	090 010 011
	Filtres	000 024 011
	Roulettes	000 025 142
	Tamis	000 024 014
	Capteur dépression	219 700 950

Pièces HYDROMEL

		LIBELLES	REFERENCES
		Bache HYDROMEL seule sans cadre avec joints EPDM 6X12	082 002 520
		Couverture polyuretane gonflable	082 001 000
		Joint de cadre mousse noire	082 002 510
		Mousse bleue plateau	082 000 771
		Limiteur de T°	210 101 200

Bavettes et passages Mains/pieds

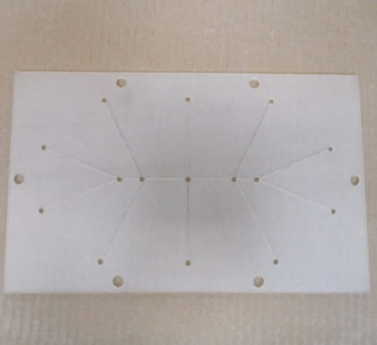
		LIBELLES	REFERENCES
		<u>CHROMOTHERM 2 :</u> Bavette d'étanchéité	050 000 017
		Arceau PVC	050 000 018
		<u>THALAXION :</u> Bavette Silicone EP 2mm	040 000 009
		Arceau PVC	082 000 365
		<u>AFFUSION</u> <u>932/952 :</u> Ecran de protection IDF seul MACROLON 2mm	041 209 995
		<u>AFFUSION 953 /</u> <u>DIME :</u> Ecran souple 800mm Silicone 2mm	082 001 045
		<u>ETUVE ET4 :</u> Passage de pieds Silicone 260X160 Type1 EP2mm	100 000 006

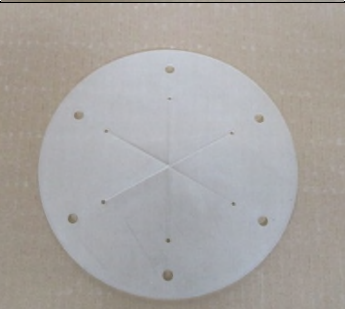
	<p><u>ETUVE ET4 :</u></p> <p>Passage de pieds Silicone 260X160 Type2 EP2mm</p> <p>Double membrane</p>	<p>100 000 033</p>
	<p><u>ETUVE ET4 :</u></p> <p>Passage Mains Silicone EP 2mm Membrane N°1</p>	<p>100 000 003</p>
	<p><u>ETUVE ET4 :</u></p> <p>Passage Mains Silicone EP 2mm Membrane N°2</p> <p>Double membrane</p>	<p>100 000 009</p>

Tuyaux et flexibles

	LIBELLES	REFERENCES
	<p><u>Flexibles tressés et bague INOX 2RTP</u></p> <p><u>½ FF :</u></p> <p>L = 500mm L = 750mm L = 1000mm L = 1250mm L = 1500mm L = 2000mm</p> <p><u>1" FF:</u> L=2500mm</p>	<p>000 025 286 000 025 289 000 025 287 000 025 292 000 025 293 000 025 288</p> <p>000 025 296</p>
	<p><u>Flexible textile tressé blanc douchette ½" :</u></p> <p>L = 1000mm L = 1600mm L = 1800mm L = 3000mm L = 3500mm <i>(Affusion 953)</i></p>	<p>000 024 222 000 024 232 000 024 221 000 024 210 000 024 285</p>
	<p><u>Tube PE NOIR (au mètre) :</u></p> <p>Ø 4-6 Ø 6-8 Ø 8-10 Ø 10-12</p>	<p>000 020 100 000 020 101 000 020 102 000 020 103</p>

	<p><u>Tube PE BLANC</u> (au mètre) :</p> <p>Ø 4-6 Ø 6-8 Ø 8-10 Ø 10-12</p> <p><u>Tube PTFE</u> (au mètre) :</p> <p>Ø 4-6 Ø 6-8 Ø 8-10 Ø 10-12</p>	<p>000 020 104 000 020 107 000 020 105 000 020 106</p> <p>000 020 110 000 020 114 000 020 115 000 020 116</p>
	<p><u>Tuyau ALPHASPIR</u> (au mètre) :</p> <p>GA1 Ø 40 GA1 Ø 50 GA1 Ø 63</p>	<p>000 020 059 000 020 060 000 020 061</p>
	<p><u>Tuyau BLANC</u> <u>S.A.S :</u></p> <p>Ø 32 / rouleau 25m Ø40 / rouleau 25m</p>	<p>000 020 045 000 020 046</p>
	<p><u>Tuyau FILCLAIR</u> <u>BLANC</u> (au mètre) :</p> <p>DN15 → 15*21 DN20 → 19*27 DN25 → 25*34 DN30 → 30*34</p>	<p>000 020 040 000 020 041 000 020 042 000 020 043</p>

	<p><u>Tuyau eau chaude (THERMOCLEAN) :</u></p> <p>DN15 → 16*25</p> <p>DN20 → 19*28</p> <p>DN25 → 25*35</p> <p>Par 20 ml ou au mètre</p>	<p>000 020 093</p> <p>000 020 094</p> <p>000 020 095</p>
	<p><u>Tuyau Silicone : (au mètre) :</u></p> <p>Ø 5-8</p> <p>Ø 8-12</p> <p>Ø 10-16</p> <p>Ø 15-21</p> <p>Ø 5-9</p> <p>Ø 9-13</p> <p>Ø 6-12</p> <p>Ø 7-11</p> <p>Ø 6-9</p> <p>Ø 7-13</p> <p>Ø 8-14</p> <p>Ø 12-17</p>	<p>000 020 200</p> <p>000 020 201</p> <p>000 020 202</p> <p>000 020 203</p> <p>000 020 204</p> <p>000 020 205</p> <p>000 020 206</p> <p>000 020 207</p> <p>000 020 208</p> <p>000 020 209</p> <p>000 020 211</p> <p>000 020 212</p>
	<p><u>Tuyau SPIRABEL ou (CORFOU) :</u></p> <p>DN30</p> <p>DN40</p> <p>DN50</p> <p>DN60</p>	<p>000 020 050</p> <p>000 020 052</p> <p>000 020 051</p> <p>000 020 053</p>
	<p><u>Gaine ALFAVAC PU :</u></p> <p>DN 50</p>	<p>000 020 120</p>